

## Solid State Relay KSI480 Series Single Phase AC Output



- Zero switching or random-on
- Ratings from 25A to 100A @ 48-530VAC
- SCR output for heavy industrial loads
- AC or DC input
- DBC substrate for superior thermal performance
- Dielectric strength 4000VACrms
- LED indication
- Internal RC/MOV and TVS protection circuit as option

### Product Description

KSI480 series industrial single phase relay with SCR output is the most widely used in industry application. The relay can be used for resistive, inductive and capacitive loads. The control input voltage is 4-32VDC or 85-280VAC, output current rate 25A, 40A, 60A, 80A, 100A @ 48-530VAC.

### Product Selection

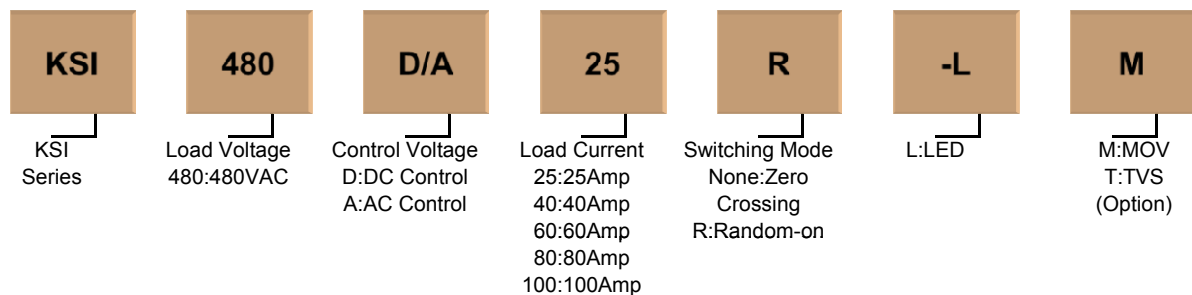

Description	25A	40A	60A	80A	100A
D:3-32VDC	KSI480D25	KSI480D40	KSI480D60	KSI480D80	KSI480D100
	KSI480D25R	KSI480D40R	KSI480D60R	KSI480D80R	KSI480D100R
AC:85-280VAC	KSI480A25	KSI480A40	KSI480A60	KSI480A80	KSI480A100

### Technical Specification

#### Input Circuit

Control Voltage Range	DC Input	4-32VDC
	AC Input	85-280VAC
Minimum Turn-On Voltage	DC Input	4VDC
	AC Input	85VAC
Minimum Turn-Off Voltage	DC Input	1VDC
	AC Input	10VAC
Maximum Input Current	DC Input	25mA
	AC Input	10mA

#### Output Circuit

Load Voltage	48-530VAC
Random-On	1ms

Maximum Turn-On Time	Zero Crossing	1/2AC Cycle + 1ms
	AC Input	20ms
Maximum Turn-Off Time	DC Input	1/2AC Cycle + 1ms
	AC Input	40ms
Maximum Surge Current [@10ms]	25A	400A
	40A	440A
	60A	860A
	80A	1280A
	100A	1550A
Maximum I <sup>2</sup> t For Fusing [@10ms]	25A	900A <sup>2</sup> S
	40A	970A <sup>2</sup> S
	60A	3698A <sup>2</sup> S
	80A	8192A <sup>2</sup> S
	100A	12012A <sup>2</sup> S
Transient Overvoltage		1200Vpk
Maximum Off-State Leakage Current [@ Rated Voltage]		3mA
Maximum On-State Voltage Drop [@ Rated Current]		1.6Vrms
Minimum Off-State dv/dt [@ Maximum Rated Voltage]		500V/μs

### General Information

Dielectric Strength, Input/Output/Base [50/60Hz]	≥4000Vrms
Ambient Operating Temperature Range	-30°C ~ +80°C
Ambient Storage Temperature Range	-30°C ~ +100°C
Weight [typical]	85g

### Application

High-low Temperature Chamber, Plastics Machinery, Incubation Machine, Oiling Machine, HVAC, Elevator, Lighting, Fountain Controller.

### Installation

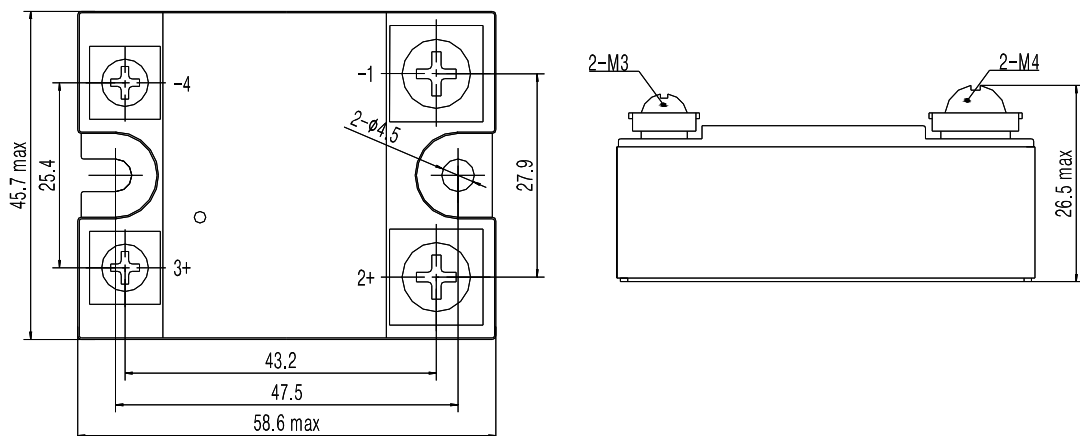

## Thermal Curve

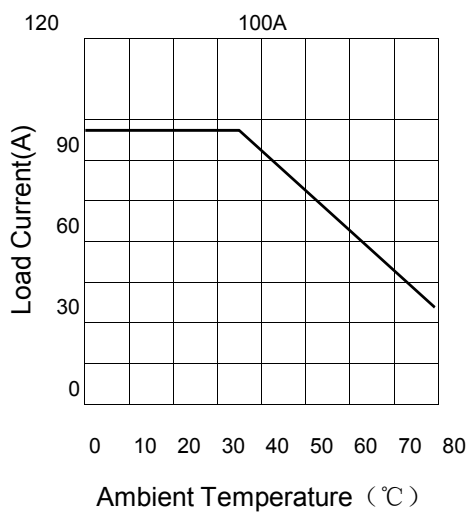
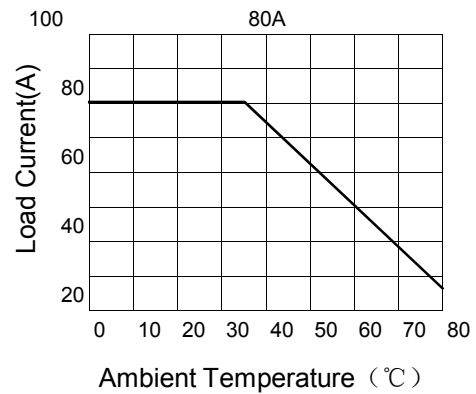
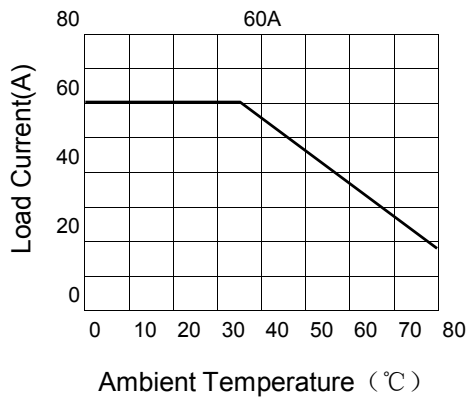
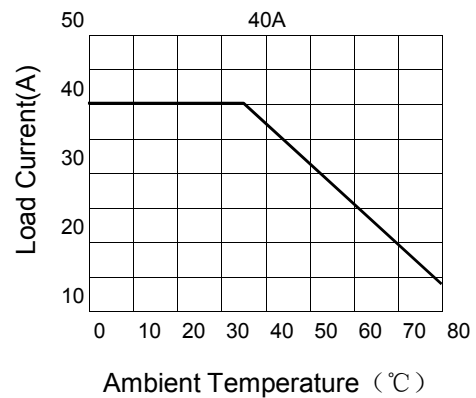
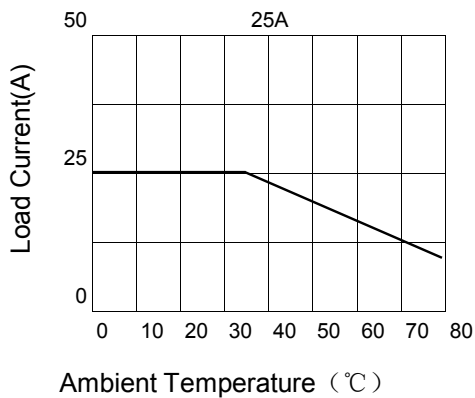

### Important Notice

1. When the ambient temperature is over 40°C or many KSI series are installed closely together, the user should take load discount into account according to the thermal curve.
2. If the load current is over 5A, suitable heatsink should be added to the SSR.
3. Plastic cover can be option depends on application to reach IP20.

### Product Certification



@Kudom Electronics Technology, All Right Reserved

Kudom Electronics Technology